

## 0805 Package SMD LED 0.8mm Height

### VS 47D8

#### Description

The major breakthrough in VS 47D8 Series is Red color emitted, package in dimension L x W x H, 2.0 \* 1.25 \* 0.8 mm. The dice used in this series is AlGaInP material rather than the conventional GaP and GaAsP/GaP. The advantages of AlGaInP are low power consumption and obtaining high luminous intensity under low current driving condition. The wavelengths and luminous Intensities of this series are grouped under 20mA for uniformity. These LEDs are suitable for multiple usages in series connection applications.

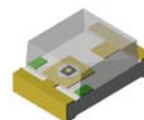

#### Applications

- Industrial control systems signal indicator
- Automotive features
- Front panel indicator
- Status indication

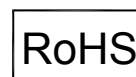

#### Electronic Optical Characteristics (at 20mA):

Part Number	Emitted Color	$\lambda$ (nm)		Lens Color	Iv(mcd)		Viewi Angle	VF(V)	
		$\lambda_d$	$\lambda_p$		Min.	Typ.		Typ.	Max.
VS 47D8	Red 	624	632	Clear	35.5	60	130	2.0	2.4

#### Absolute Maximum Ratings (at Ta=25°C)

P <sub>D</sub> (mW)	I <sub>FP</sub> (mA)	I <sub>F</sub> (mA)	Iron Solder (°C)	I <sub>R</sub> (uA)@V <sub>R</sub> =5V	Topr(°C)	Tstg(°C)
60	100*	25	350 ± 5 for 3 sec.	10	-40~+85	-40~+100

Note: Please take note the Absolute Maximum Rating values. Any operation beyond the specify ratings in this table will result degradation of LED life-span and may cause LED to fail.

\* I<sub>FP</sub>: Peak Forward Current under 1/10 duty, 1KHz condition

**Package Dimension:**

unit : mm

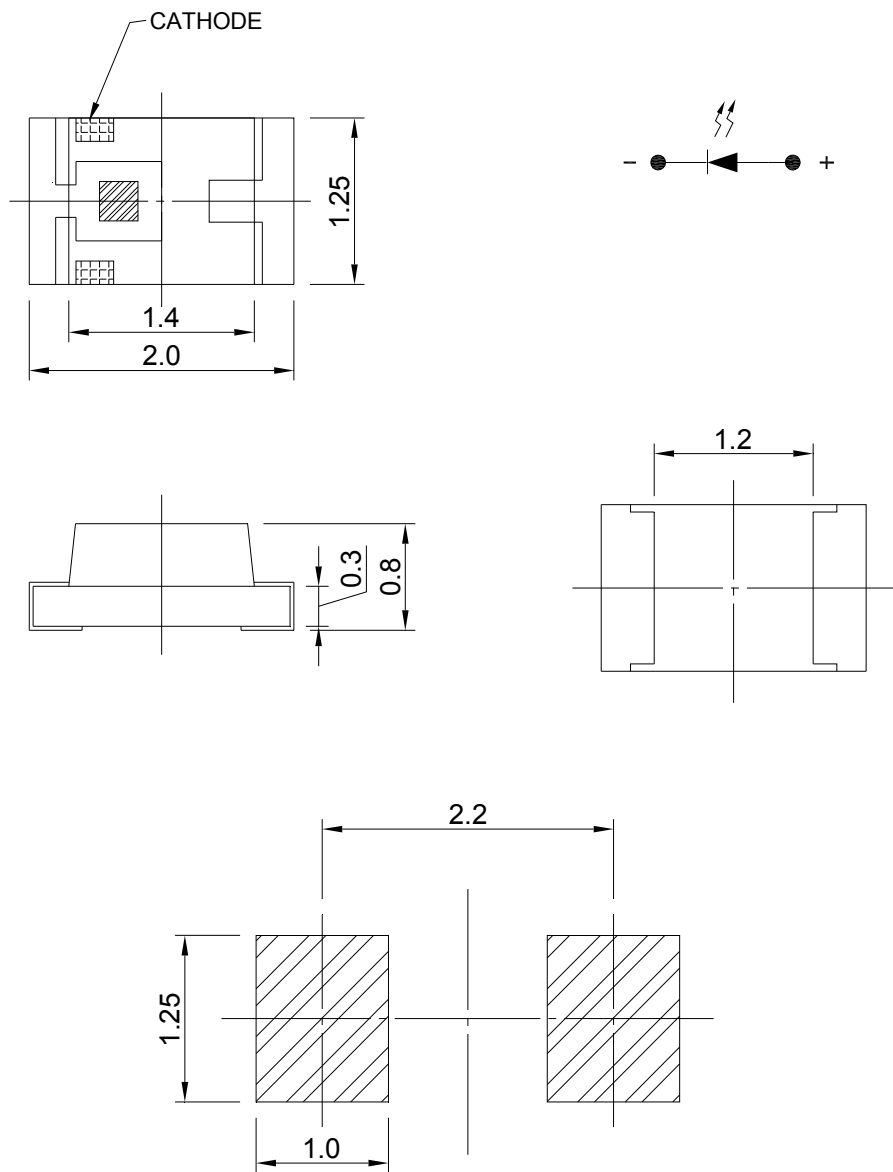

Recommended soldering Pad

**Notes:**

1. All dimensions are millimeters.
2. Tolerance is  $\pm 0.2\text{mm}$  unless otherwise specified.
3. Specifications are subject to change without notice.

### Optical Characteristics Curves

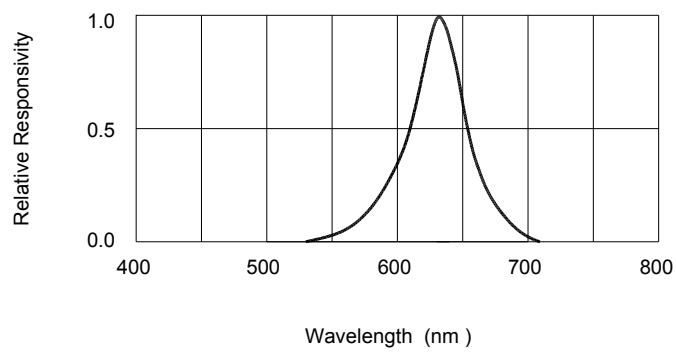
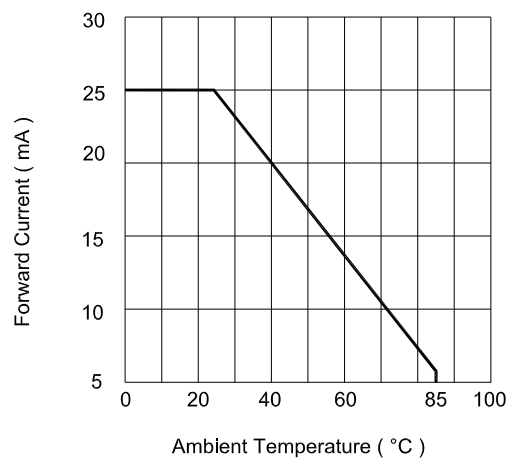
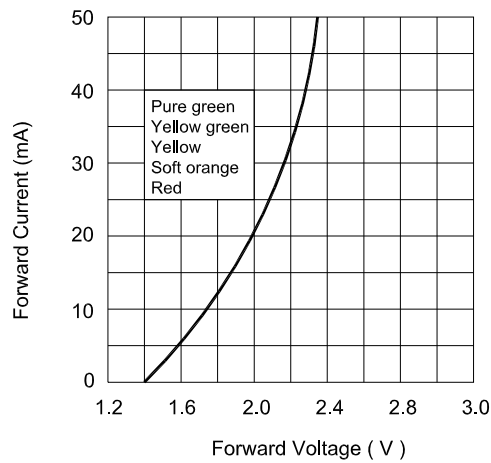
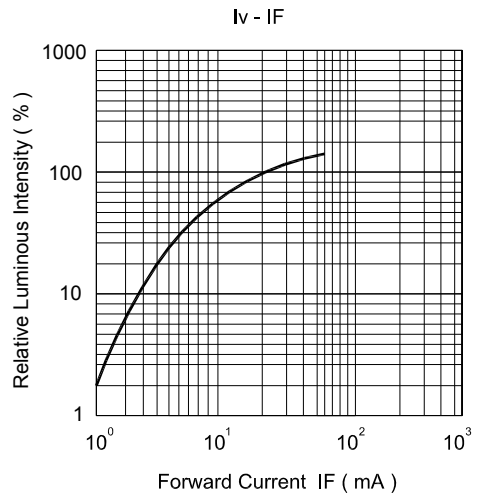
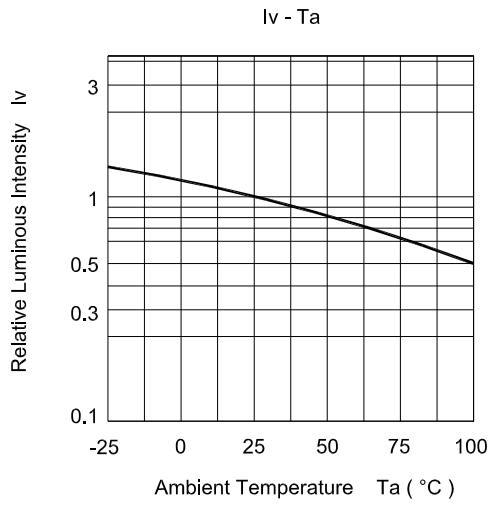

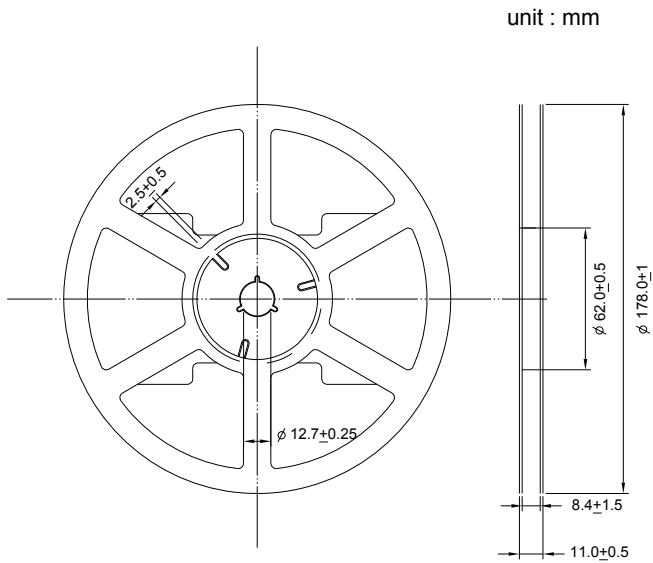
**Reel Dimension:**

**Note:**

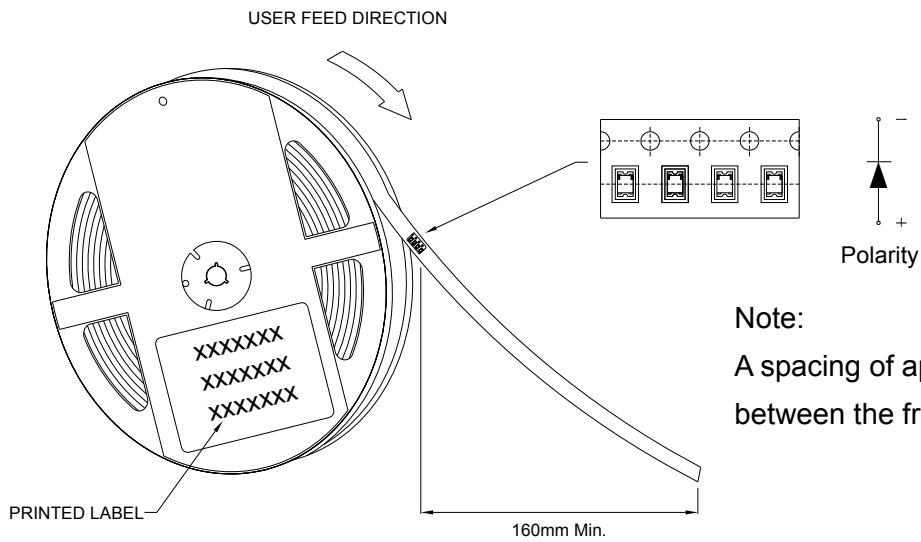
Available in 8mm carrier tape on 178mm diameter reels. (3000 pieces)

**Note:**

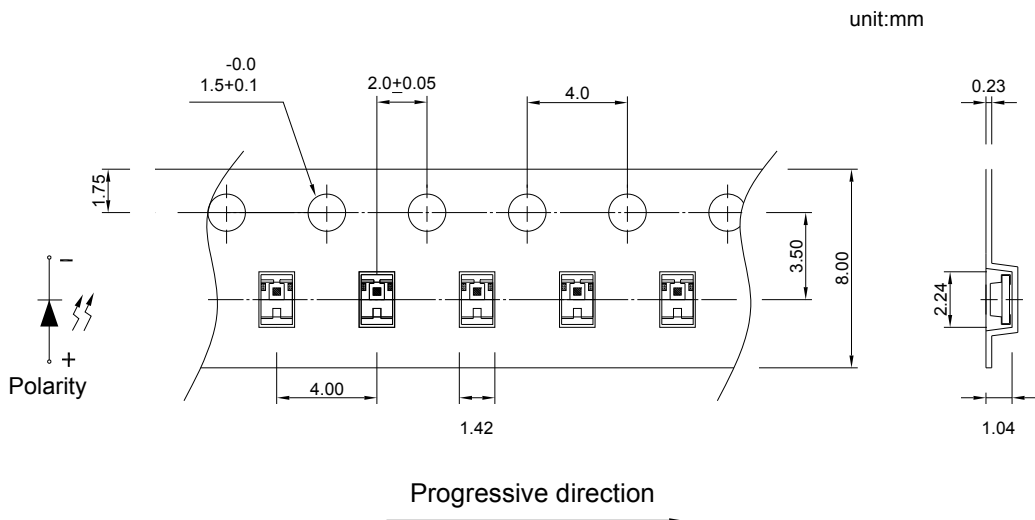
A spacing of approximately 160mm between the front edge of tape

**Tape Dimension:**

**Recommended re-flow soldering profile:**

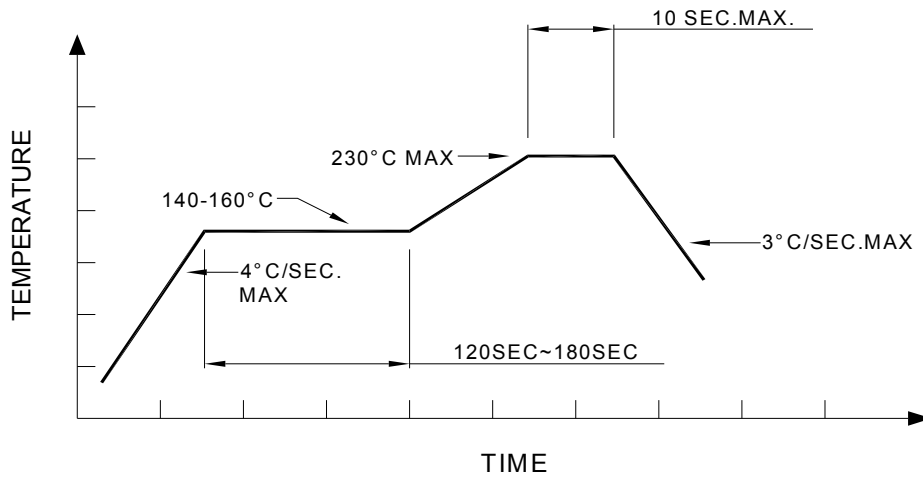

**Recommended Pb-free re-flow soldering profile:**

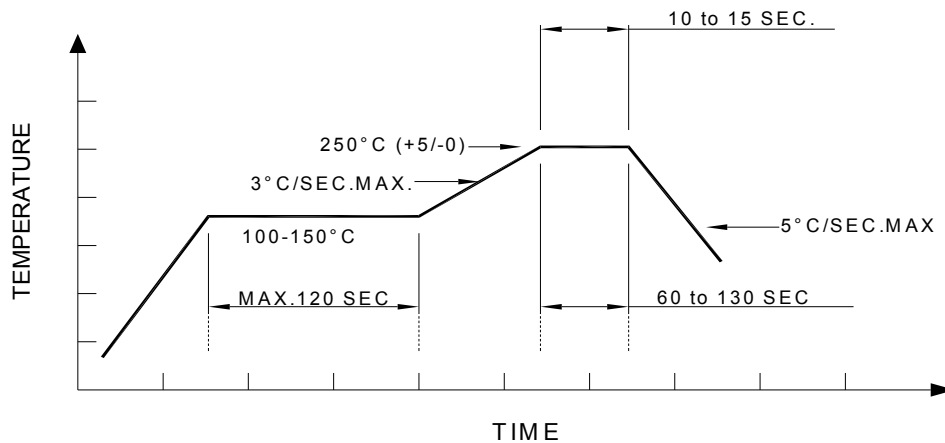

**Note:**

All the specifications listed in this data sheet are suitable for general electronic equipment, office equipment and communication devices. Kindly consult Sales Representatives for specific reliabilities request, Forward Voltage, Luminous Intensity, Wavelength, Radiant Power or Viewing Angle.