



FULL MOST CO., LTD.

ADD : 8 F, No.220, Sec. 1, Zhongshan Rd., Yonghe City, Taipei County 234, Taiwan

TEL : +886-2-2927-1858 FAX : +886-2-2927-0355

E-mail : tessie.lin@fullmost.com.tw http://www.fullmost.com.tw

The result of the conversion and measured reports shows

- The structure of the brick style honeycomb panel is much stable than the tubular type

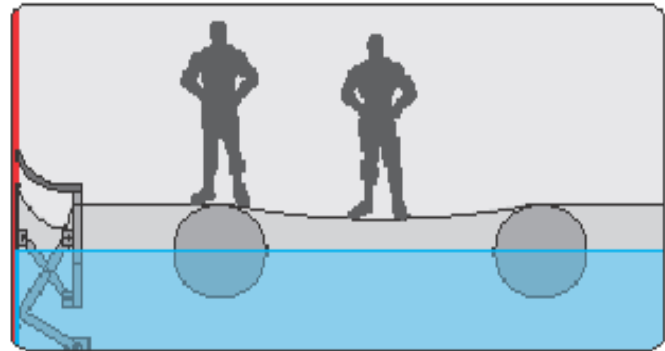
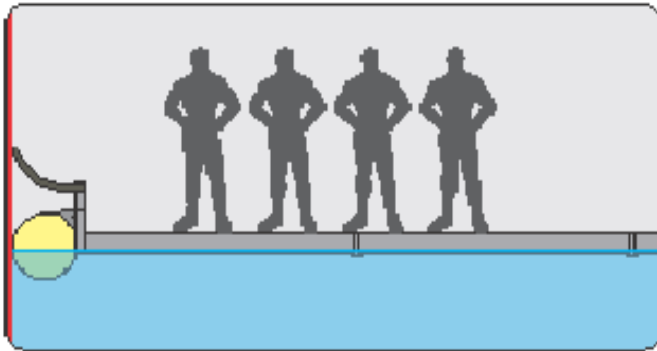

There are more than 1000 independent honeycomb cores per square meter

With independent and discontinuous cores the buoyancy of brick style honeycomb panel will not be affected even if it suffers punctured damage. Tubular type needs two more standby tubes to avoid broken holes which may cause the floating roof to sink.

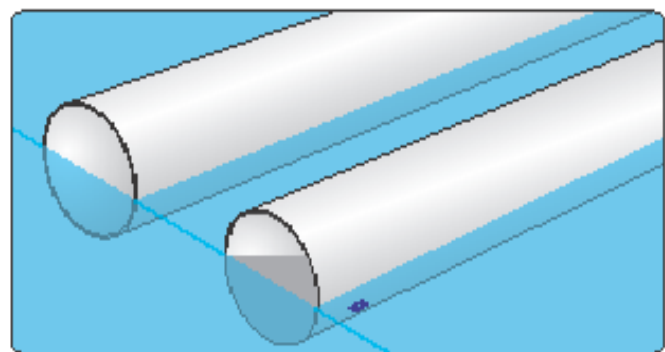
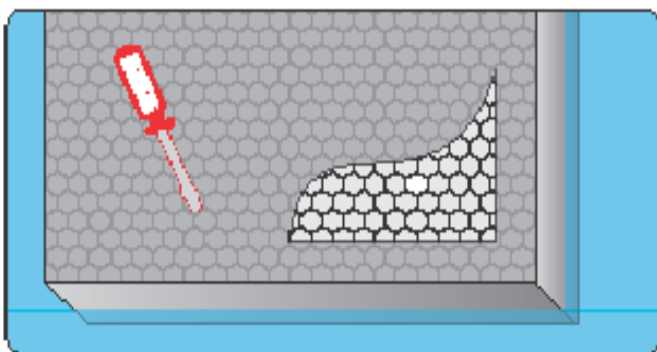

the safety of the Brick style honeycomb panel has been increased

- The Brick style full contact honeycomb design cannot be soaked by liquid. Sandwich type honeycomb is easy to become soaked and peel off, causing the floating roof to sink.

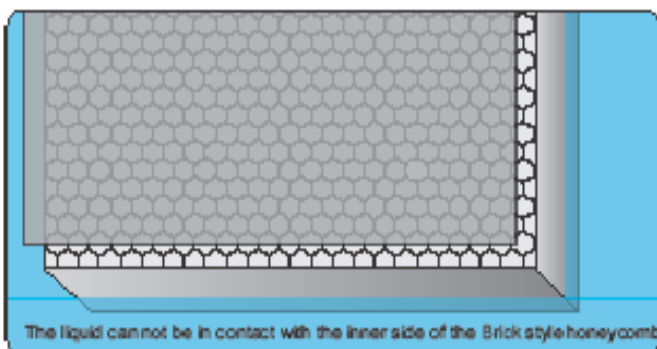

The liquid cannot be in contact with the inner side of the Brick style honeycomb

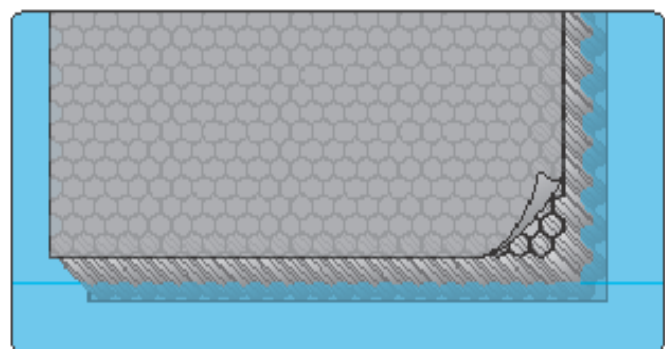



Seal type

▶ Single



Foam Seal

Mech.
Shoe Seal

Wiper Seal

▶ Double

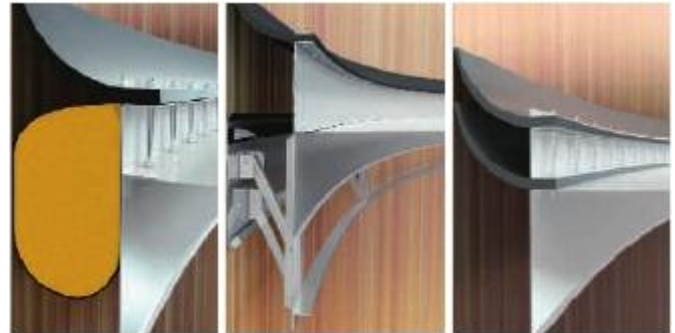

Foam Seal
with
Secondary
Wiper Seal

Mech.
Shoe Seal
with
Secondary
Wiper Seal

Double
Wiper Seal

Rim Seal Comparison

Type	Foam Seal with Wiper	Mechanical Seal with	Double Wiper Seal
Sealing Efficiency	good (API2519 loss factor	good (API2519 loss factor 1.6)	Acceptable (API2519 loss factor 2.5)
Maintenance	low maintenance (envelope check required)	high maintenance (all metal)	no maintenance
Installation	easy	Complex (need to check bolting tightness & highly demanding	easy
Tank Application	suitable for new and old; big and small tanks	not suitable for old and small	suitable for new and old; big and small tanks
Storage	suitable for most storage	suitable for all storage	suitable for all storage fluid
Shockproof	good	weak (easy to get stuck in storage tank)	good
Loading Distribution	average	high circumference weight	average
Vapor Space	no	yes	yes
Generate Static Electricity	no	easy	no
Material	low	high	low



FULL MOST CO.,LTD.

ADD : 8F., No.220, Sec. 1, Zhongshan Rd., Yonghe City, Taipei County 234, Taiwan

TEL : +886-2-2927-1858 FAX : +886-2-2927-0355

E-mail : tessie.lin@fullmost.com.tw <http://www.fullmost.com.tw>

Sandwich style honeycomb sunk

