

Wireless BT CCD Scanner

270
scans/
secs rate

Bluetooth
WIRELESS

Flexible
communication
options

SMART
POWER
MANAGEMENT

LONG
WIRELESS
RANGE UP
TO 90M

FCC,
CE AND
ROHS
CERTIFIED



Wireless battery charge

Durable

Economical

Handheld wireless CCD Scanner

The BC-6500BT is CCD wireless scanner which is able to communicate to the devices such as laptops and mobile phone devices. It has connected up to 90M work range. It combines energy efficiency and high performance with the unprecedented versatility.

The BC-6500BT has a secure range of up to 90 meters and an aggressive and robust linear imager that scans 270 times per second. BC-6500BT's high performance, ergonomic design combines simple reliability with the flexibility and convenience of a wireless scanner. This highly reliable scanner is for daily retail industry and office environment.



Rugged Wand-Type Metal Housing



Replacable Tip for Easy Maintenance

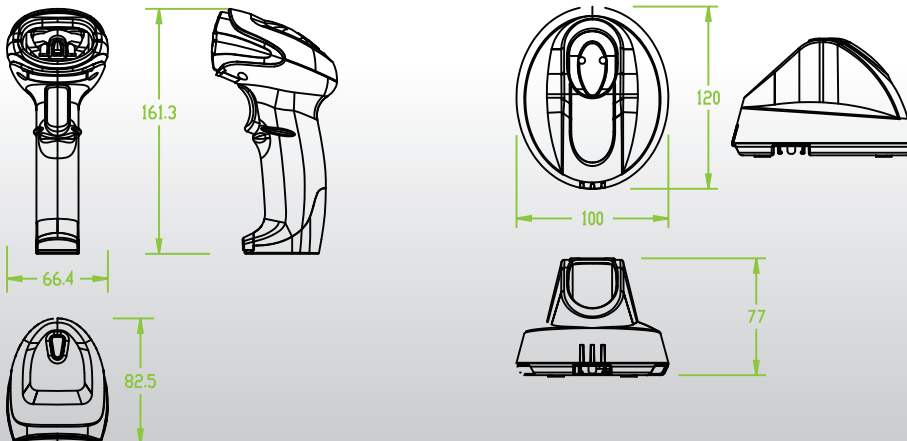

Feature

- ◆ 270 scans/secs rate
- ◆ Bluetooth WIRELESS
- ◆ Flexible communication options
- ◆ SMART POWER MANAGEMENT
- ◆ LONG WIRELESS RANGE UP TO 90M
- ◆ FCC, CE AND ROHS CERTIFIED

Typical Performance	
Narrow Width	Depth of Field
5 mil	27mm – 151 mm (1.1" – 5.9")
7.5 mil	16mm – 216mm (0.6" – 8.5")
10.4 mil	0mm – 277mm (0" – 10.9")
13 mil	0 mm – 311mm (0" – 14.4")
20 mil	0 mm – 367mm (0" – 14.4")

Resolution: 3 mil
Performance may be impacted by bar code quality and environmental conditions

Specifications

General	
Interface	HID USB / USB COM Port evaluation
Barcodes supported (1D)	All UPC/EAN/JAN, EAN 128 code, Code 39, Code 39 full ASCII, Code 32/Italian Pharmacy, Code 128, CODABAR/NW 7, Interleave 2 of 5, Industrial 2 of 5, Matrix 2 of 5, MSI/PLESSEY, Telepen, Code 93, Code 11, China Postage, GS1 DataBAR
Communication	
RF Standard	BT 4.0
Working Distance	90M (Open environment)
Optical	
Optical Sensor	2500 pixels
Light Source	Red LED (660nm)
Resolution	4 mil
Depth of Field	30 – 200 mm (13mil)
Scan rate	270 scans/sec
PCS	45%
Electrical	
Voltage	DC 3.3V
Scanning Currents	110 mA
Standby currents	<90 mA
Environment	
Operating temperature	0°C to 40°C (32°F to 104°F)
Storage temperature	-20°C to 60°C (-4°C to 140°C)
Relative Humidity	10% - 90%
Drop	1.5m drops
Physical	
Weight	185g (w/o cradle)
Dimensions	82.53mm (L) x 66.4mm (W) x162.08mm (H)
Housing Material	ABS plastic
Battery	
Battery Type	Polymer 3.7V
Battery Capacity	2600mAh good for 50,000 scan per charge
Charge	By USB power retrieving cable or cradle wireless charge
Time of Charge	About 5 hours